

Copyright 2004

Child's Bench Toy Box

-- Freebie

This Child's Bench Toy Box features a large toy box with a bench back and arm rests. It also has casters, an internal tray, and a secret compartment underneath. It can be build from materials readily available from your local home fix-up store or mail order house.

The box design is take from simple New England plank boxes but uses the new edge glued board product to replace the no longer available wide wooden planks. It does include the traditional course dovetail joints which can be make with only a few hand tools.

The back and arm rests features pre-made spindles and can be removed if the box must be shipped. These are held on with carriage bolts.

The patterns for this box serve very well as a [first lesson](#) in wood carving.

You can buy all the materials for this box at your local home store or mail order the spindles and piano hinge from:.



• Download the Detailed Drawings

This free design includes six detailed sketches. You can click on the link below to download sample drawings drawings in .PDF format. These construction notes cover all the box varieties and can be printed out with your Web browser.

1. [Child's Box/Bench Drawings in .pdf](#)

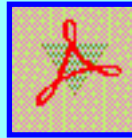

2. A free Acrobat Reader (.87 meg) is available from:
3. Or, if these don't work or you need a new name and flower pattern, simply send in this [little freebie form](#).

• box Construction

You can make this box by:

1. Downloading the drawings and this text.
2. Studying this information and locating the materials.
3. Purchasing all the materials locally or by e-mail order.
4. Having the panels and plywood cut at the store.
5. Hand cut the dovetail joints
6. Hand cut and drilling the small pieces.
7. Gluing up parts.
8. Assembling the box.
9. Decorate the box.
10. Finishing all pieces

• Discussion of Sketches

After you download the sketches, these notes will help you understand them more completely.

1. **Child's Bench Toy Box**

The front view shows the box with its dovetail joints and the back with its spindles. Note the casters and the decorations which can be simply carved or stenciled.

The side view shows the arm rest (also with spindles) the recessed bottom for the casters, the end of the internal tray, and the curve the lid makes when opened.

2. **Child's Bench Toy Box, Wide Boards, Sketch #2**

This sketch is shows the wide factory glued up boards used for the front, back, top, and ends. These come in standard sizes and the design is adjusted to use them. The top has a 1-by-6 at the back.

3. **Child's Bench Toy Box, Back and Arms, Sketch #3**

This sketch shows the wooden pieces that make up the back and arm rests. These are all made from standard size lumber. The spindles are mail order. Most of the parts are 1-by-2 stock that can be cut with a simple hand saw and miter box. The back top can top can be cut with a jig saw or coping saw.

4. **Child's Bench Toy Box; Bottom, Tray, and Secret , Sketch #4**

These are the pieces of wood and plywood needed for the bottom, tray, and secret compartment. The major plywood cuts can be made at the store. The bottom is simply 1/2 inch plywood with four 4 inch square corner blocks to provide extra thickness for the casters.

The internal tray is long and narrow. It can slide front to back and hold small things that would otherwise be lost at the bottom of the box. It is made from 1/4 inch plywood and 1-by-2 frame.

The secret compartment is a wide but very thin compartment that fits between the casters underneath the box. It is held up by magnet latches and hinges. It can be released with the fingers or a pencil. Its thickness of just over an inch limits its use to small things such as a diary, or sketch book, or such. A secret place can be very important to a child.

5. **Child's Bench Toy Box, Carving, Full Size , Sketch #5**

This is a full scale out line for a flower that can be either carved using a single gouge (see below) or cut-out and stenciled on.

6. Child's Bench Toy Box; Dove Tail Gage, Sketch #6

This is a full size pattern for a dovetail gage to help you make the course dovetails used for the corners of the box (details below).

• Materials

This box uses four commercial edge-glued pine panels, plywood, and dimensioned pine lumber.

1. Wood

Edge Glued Panels:

- 4 -- Pine Edge-glued panel, 18 by .75 by 47.5 inches, \$17.00 each -- \$68.00

With only slight modification of the drawings, this box can be made slightly smaller out of 16 by 48 inch panels.

Plywood:

- 1 -- Fir, .50 in., A/C, 2x4 feet, \$8.00 each -- \$8.00
- 2 -- Fir, .25 inch, A/C, 2x4 feet, \$6.00 each -- \$12.00

Dimensioned Lumber:

- 8 ft -- Pine, 1-by-6, -- \$5.00
- 66 ft -- Pine, 1-by-2, \$, \$.39/ft -- \$ 26.00
- 10 ft -- Pine, 1-by-1, .75 by .75 inch molding, \$.37/ft -- \$ 3.70
- 36 inches -- Dowel 5/16 inch -- \$1.25

(.5 by .75 stock is acceptable, or cut these blocks from scrap lumber)

Spindles:

- 11 -- Baby Crib Spindle Oak (H) 10 inch -- \$2.30 each -- \$25.30
- 10 -- Baby Crib Spindle Oak (H) 7.5 inch -- \$1.70 each -- \$17.00

Wood Subtotal: \$166.25

2. Hardware

- 2 -- Fixed Casters, 2 inch -- \$ 5.00
- 2 -- Swivel Casters, 2 inch -- \$ 5.50
- 1 -- Piano Hinge(H), 48 inch, antiqued -- \$9.00
- 3 -- Hinges(H), 1-1/2 inch -- \$4.00
- 4 -- Bumpers(H), 3/4 inch, nail -- \$1.50
- 2 -- Magnet latches (H)-- \$3.00
- 100 -- Screw, flat head, #8 1 inch -- \$ 3.20
- 16 -- Screw, Pan head, #12 1 inch -- \$ 1.50
- 4 -- Carriage Bolt, 5/16 inch, 2.5 inches long -- \$ 1.00
- 4 -- Carriage Bolt, 5/16 inch, 3.0 inches long -- \$ 1.00
- 4 -- Carriage Bolt, 5/16 inch, 3.5 inches long -- \$ 1.00
- 12 -- Flat Washers, 5/16 -- \$.50
- 12 -- Nuts with plastic inserts, 5/16 --- \$1.50
- 1 box -- Restoration Steel cut nails 1.5 Inch (H) -- \$2.50
- 1 box -- #3 Finishing Nails, 1-1/4 inch --- \$1.50
- 4 -- Wooden screw cover plugs (H) -- \$ 1.50
- 8 oz. -- Woodworker's Glue -- \$ 3.80
- 1 package -- Wooden Wedges -- \$ 3.00

Hardware Subtotal: \$ 50.00

3. Finish:

- 1 qt. -- Paint, oil based -- \$ 7.00
- 1 qt. -- Shellack -- \$ 5.00
- 1 pt. -- Shellack thinner -- \$ 4.00
- 1 qt. -- Polyurethane varnish, satin finish -- \$12.00
- misc. -- Decoration paint (see below) -- \$ 10.00

Finish Subtotal: \$ 38.00

4. Omissions and Contingencies (~15%)

(Tax, sand paper, etc.) \$20.75

5. Estimate Total Cost \$275.00

This is only an estimate (made in the May 2000). The price may vary in your area.

• Tools

This box was designed to be build using only a few hand tools that a home owner might have, purchase at reasonable cost, or borrow. These tools are all useful for general around-the-house maintenance and can fit in a tool box.

1. Electric Drill, 3/8 chuck
2. Screw Mate bit for #8 screws -- \$6.20 new
3. Miter Box and hand saw -- under \$20.00 new
4. Tri-Square
5. Screw drivers
6. Hammer and small nail set
7. Small Block Plan -- \$14.00
8. Four-in-Hand Rasp -- \$6.00
9. Dowel Centers -- \$4.00

You will also need sand paper, paint brushes. etc.



• Building Your box

This is your box and you can build it to suit your likes and needs.

1. Customize the Box to Suit Your Needs

1. Custom Size

The edge glued panels come in several sizes with the exact dimensions varying with the manufacturer. This box as shown is rather large.

If you like 16 inch wide panels for the sides, ends, and top panel. This will make for a medium sized box that younger children can use more easily. The ends need to be cut 1/2 inch shorter to 20.5 inches. The length of the 16 inch panels I saw was also 48 inches instead of the rather odd 47.5 inches shown.

If you have a table or radial arm saw available you may adjust the size of the panels to suit your needs.

2. **Inside Tray**

The inside tray is very important for placing small toys in. Otherwise they get lost in the bottom of the box under the big toys. It should cover no more than 1/2 the open space. The inside tray is shown running the full length of the box and sliding front to back. You could build two smaller trays that run front to back and slide side to side.

3. **Decorations**

The decorations shown are very simply carved into the panels. This requires a two special tool and two home made ones. This is not difficult but the knotty-pine edge glued panels are not particularly easy to carve either. You may choose instead to simply stenciled decorations on the box or paint it several colors like a circus wagon.

For a boy you may wish to decorate the box with sailboats or airplanes instead of floors. Don't make the design too cutsie or the child will hate the box as a teenager. Having the child's name on the box is most important.

4. **Secret Compartment**

The secret compartment under the bottom is a lot of fun but not really very practical.

2. **Cutting the Plywood and Panels**

Sketch #2 shows the edge glued panel lay out and Sketch #5 shows the plywood layout. You can have these cuts made at the supplier before you take the material home but be very sure you get the cuts right. This will make very straight cuts.

The rest of the cuts can be made with any fine toothed saw. A jig saw working against a straight edge does well and back board cuts coping saw or a jig saw.

3. **Dove Tail Joints**

Dovetail joints are classic for this type of box, look great, and are very strong but do take a little hand work. You can do them with only a few hand tools but it does take a little practice. (Use the scrap between the end pieces for practice.) The course joints needed for this box do not have to be a perfect fit.

Note that the dovetail shapes show at the front and that the joints are locked with a few finishing nails (no glue).

Sketch #6 shows a simple 30 degree tool to aid in marking out the dovetails. It is full size and you can transfer the shape to a piece of card board (shellacked) or sheet metal. Whenever you need a sloped line you simply slide the tool along the edge of the wood and mark the angle. It is more important that all angles be the same than they be exactly 30 degrees.

After practicing on scrap wood, start with the back. Draw a light line .75 inches in from the ends. Use the tool to make off the four sloped lines and the tr--square to come straight across the end grain. Use the miter box saw to cut four angled cuts being very careful to just leave the line.

Use a coping saw or jig saw to cut out the waste. use a rasp and chisel to remove any irregular saw marks. This is the step that needs practice.

Clamp the end piece that will mate with your we work inside to inside with the front piece. Use a square to transfer the exact cut lines to the end piece end grain. Use the Dovetail tool to mark off the angles on the end grain.

Hold the two pieces together at the final right angle and very carefully mark off the material to be removed. Draw a line .75 inch in on both sides and number the joint so that you will not later get them confused.

Use the Miter Box saw to cut the angle lines. Be very sure which side of the line you want to be on. Cut the waste away with a coping saw or jig saw. Clean up the saw cuts with the rasp and chisel. Check the fit. Remove small amounts of material with a chisel until you get a good fit.

Repeat this procedure for the four corners.

Drill holes for the 15 finishing nails in the four joints using a common #6 finishing nail. Tack the nails in to temperately hold the joints but leave 1/4 inch showing so you can later remove them and drive in the antique nails. You can temporarily install the casters if it makes the box easier to work on.

4. **Fit the Bottom**

Fit the bottom plywood inside the box. Glue and nail the four caster blocks on the corners. Glue and nail small blocks around the inside of the box to hold the bottom in place so that casters stick down 1 inch. Hold the bottom in place with a few screws but do **not** glue it.

5. Fitting the Lid

Install the hinge with a few screws and trim the lid and the back piece to fit the top of the box. Round off all exposed edges with the box plane and rasp.

Nail and glue three small blocks across the back at the top and predrill screw holes up from the bottom at an angle. These screws will be a little hard to install but they will not be seen. (Do not glue) Remove the front part of the lid and the hinge.

6. Making the Back

Cut the back upright pieces in the miter box. Use a wooden wedge to hold the upright at an angle in the miter box to cut the bottom end. Try fit the uprights to the sides. Cut the two bottom spindle boards to the exact length needed. Mark the places for the spindle holes. Nail and glue on the strips together being careful not to nail at the spindle holes.

Cut the back board with a coping or jig saw. Match the spindle holes marks on the bottom spindle boards. Glue and nail on the stiffener board to the top board.

Drill the spindle holes. Fit the two outside pieces for uprights, cut the notch for the top board, and cut-out the box top. Plane of the lower back edge of the bottom spindle boards to match the slope of the back.

Trial fit the back to box and hold it with 'C' Clamps. When you have it where you want it, drill bolt holes and counter sinks for the back arm bolts. A few short dowels between the bottom spindle boards and the box top will add strength.

When you have it the way you want it, nail, glue, and screw the back together. Drill the the bolt holes in the ends.

7. Make the Arms

The arms are very like the back. They do have spacer boards to allow room for the lid to open. The front upright is two 1-by-2's and is glued to the armrest with two dowels. Having a set of dowel centers makes this operation much easier.

8. Make the Inside Tray

Cut the outside tray support from 1-by-2 with a notch for the back upright. Nail and glue a

straight piece of .75 inch square stock inside this for the tray to slide on.

Make the tray from 1-by-2's and 1/4 inch plywood to fit on the runners. Cut the hand holes with a coping or jig saw from drill holes. Nail and glue the tray together. Pre-drill holes for #6 finishing nails.

9. Make the Secret Compartment

The secret compartment is made much like the tray but has only three sides. It fits loosely between the caster blocks and the front and back boards. A piece of .5-by-.75 stock goes across the front to support the open end.

Attach the compartment to the back with hinges. Install the three magnetic latches so that they hold up the compartment. Put one near each end and one in the middle. Notch the front support piece if necessary. Drill two finger holes in the compartment bottom and two pencil sized holes in the box bottom near the magnetic latches so the compartment can be pushed open from the inside if necessary. Rasp and sand all edges so that the compartment moves easily.

10. Disassembliability

Take the box completely apart for carving, rasping, and sanding.

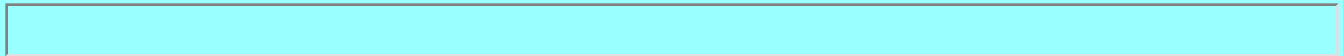

• Finishing

You may finish your project any way you like. We recommend:

- Disassemble completely
- Carve decorations (optional)
- Paint into carved decorations (optional)
- Round all corners with rasp and sand paper
- Sand with course and fine paper.
- Reassemble
- Prim with thinned shellac
- Sand with fine paper
- Stencil decorations (Optional)
- Paint the inside of the box a bright solid color
- Finish the outside with polyurethane

- Sand with fine paper
- Finish with a second coat of polyurethane

Two coats of polyurethane should last for many years but you may want to use three for heavy usage.

1. Decoration

You can decorate the box by carving in a simple pattern, stenciling, or simply painting it many colors. Having the child's name on the box is very powerful.

I have a separate construction note on very simple carving with only a few tools. (Not yet complete). Stenciling supplies are available at most arts and crafts stores.

2. Reassembly the Box

Large dovetails like these are normally **not** glued. This lets the box adjust to slightly uneven floors and wood movement over time. Drive the nails slightly below the surface. Also use only screws for the bottom and under the lid.

Wait until after completely finishing to reinstall the hinges, back, arms, tray, compartment, bolts, and casters.

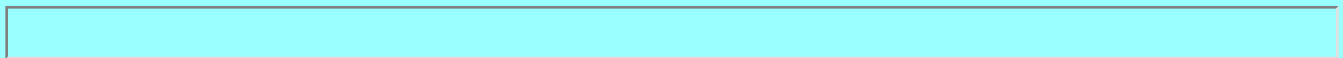

Conclusion

Thanks again for using a Woodware Computer Furniture Plans. We very much want to know how you are getting along with your project and would be happy to answer any questions by email.

If you send us a picture of your finished project, we would be happy to put it on our web page. We need pictures of boxes with real people standing beside them.



[Return to Freebie Page](#)

Woodware Designs, jriley@charm.net

Child's Bench Toy Box

Woodware Designs

<http://www.charm.net/~jriley/woodware.html>

Tom Riley
05/13/00
childbox.skf

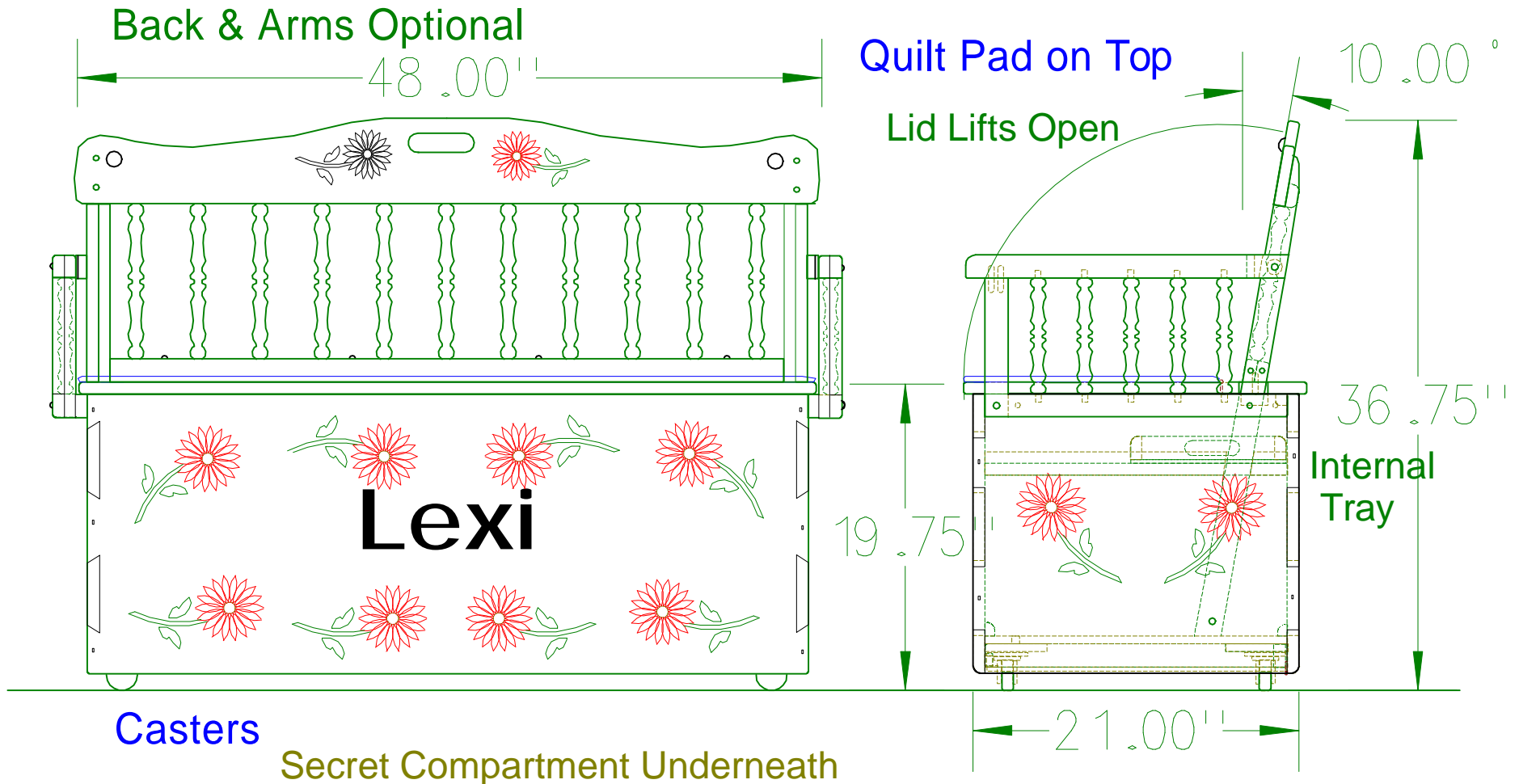

Child's Bench Toy Box

Back and Arms, Sketch #3

Back

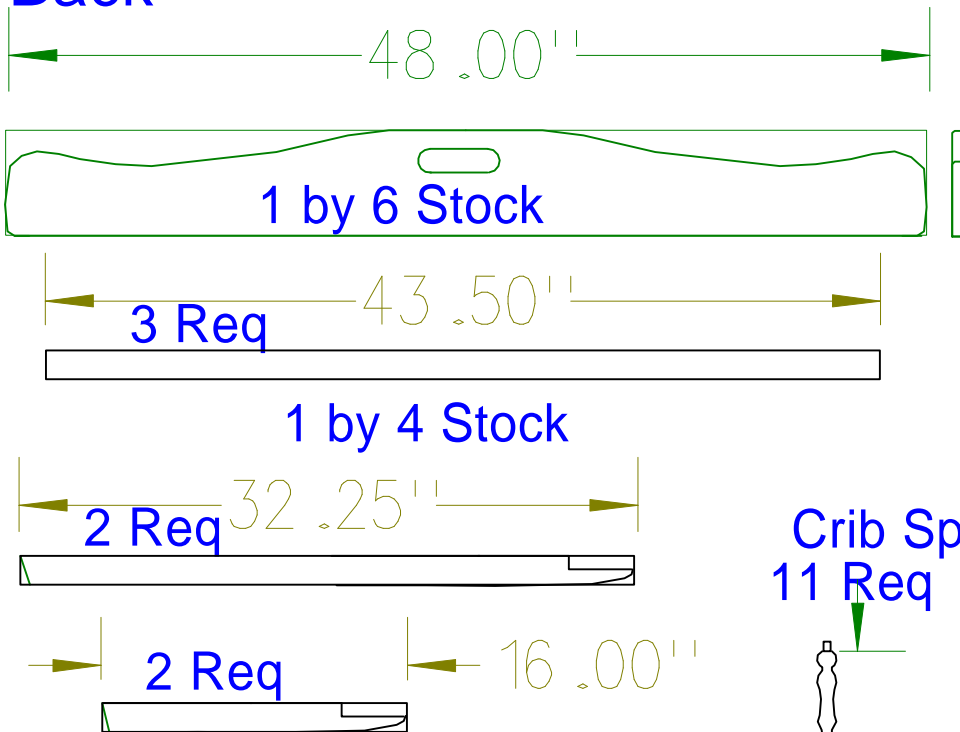

Crib Spindles

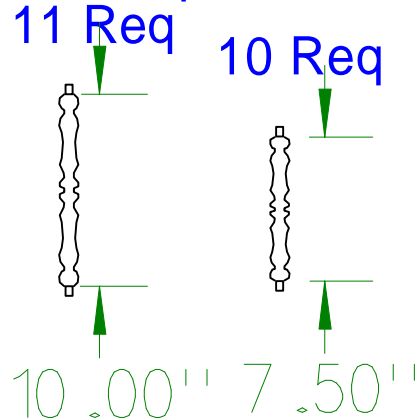

(1 by 2 Stock)

Arms

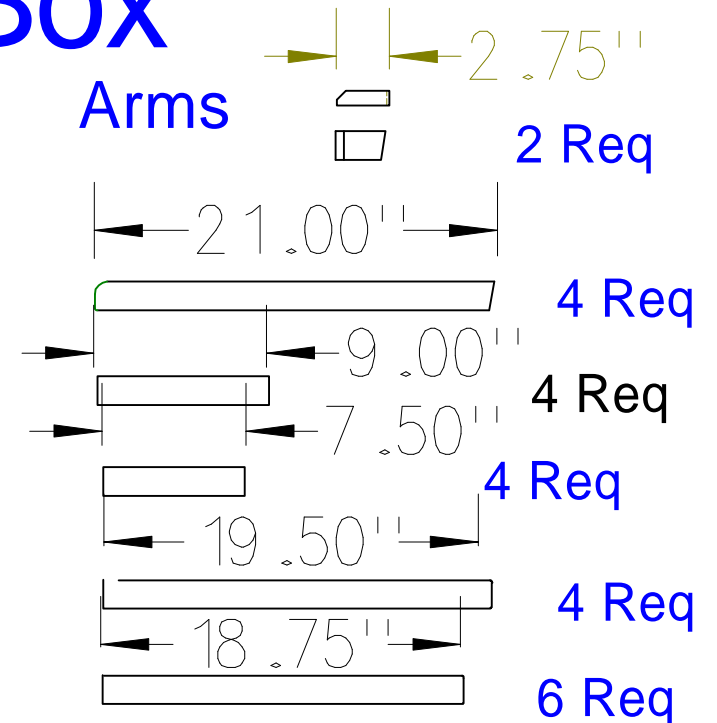

Edge Blocks



Tray Runners

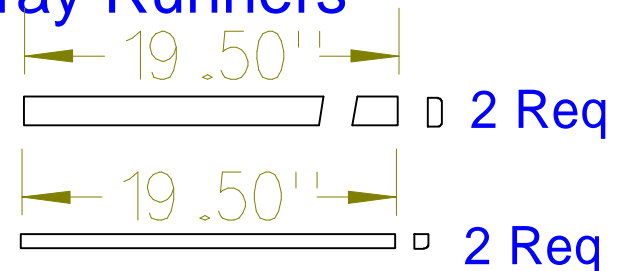

Child's Bench Toy Box

Carving, Full Size, Sketch #5

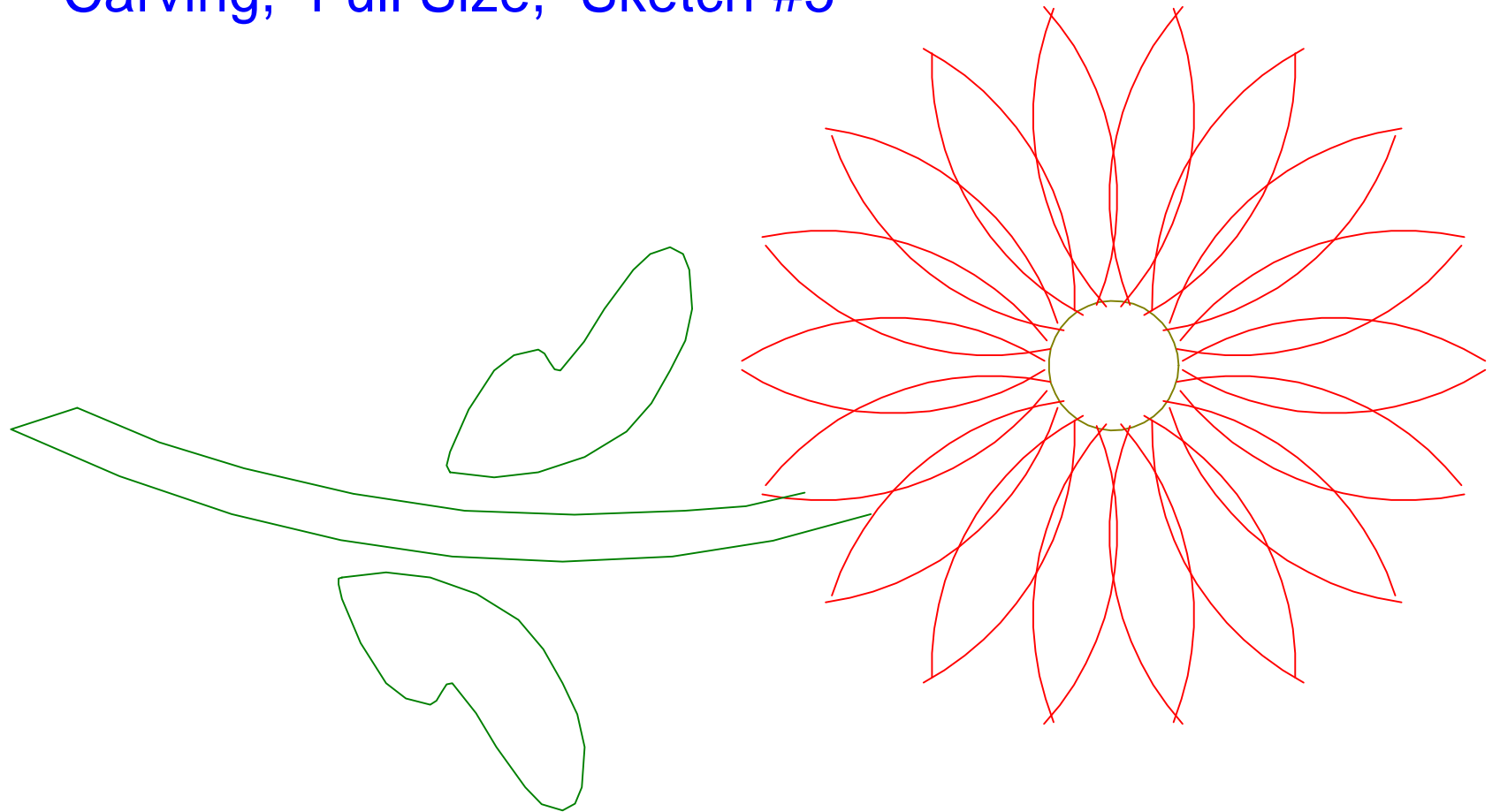

Child's Bench Toy Box

Wide Boards, Sketch #2

Edge Glued Pine Panels
(18" x 47.5") 4 Req

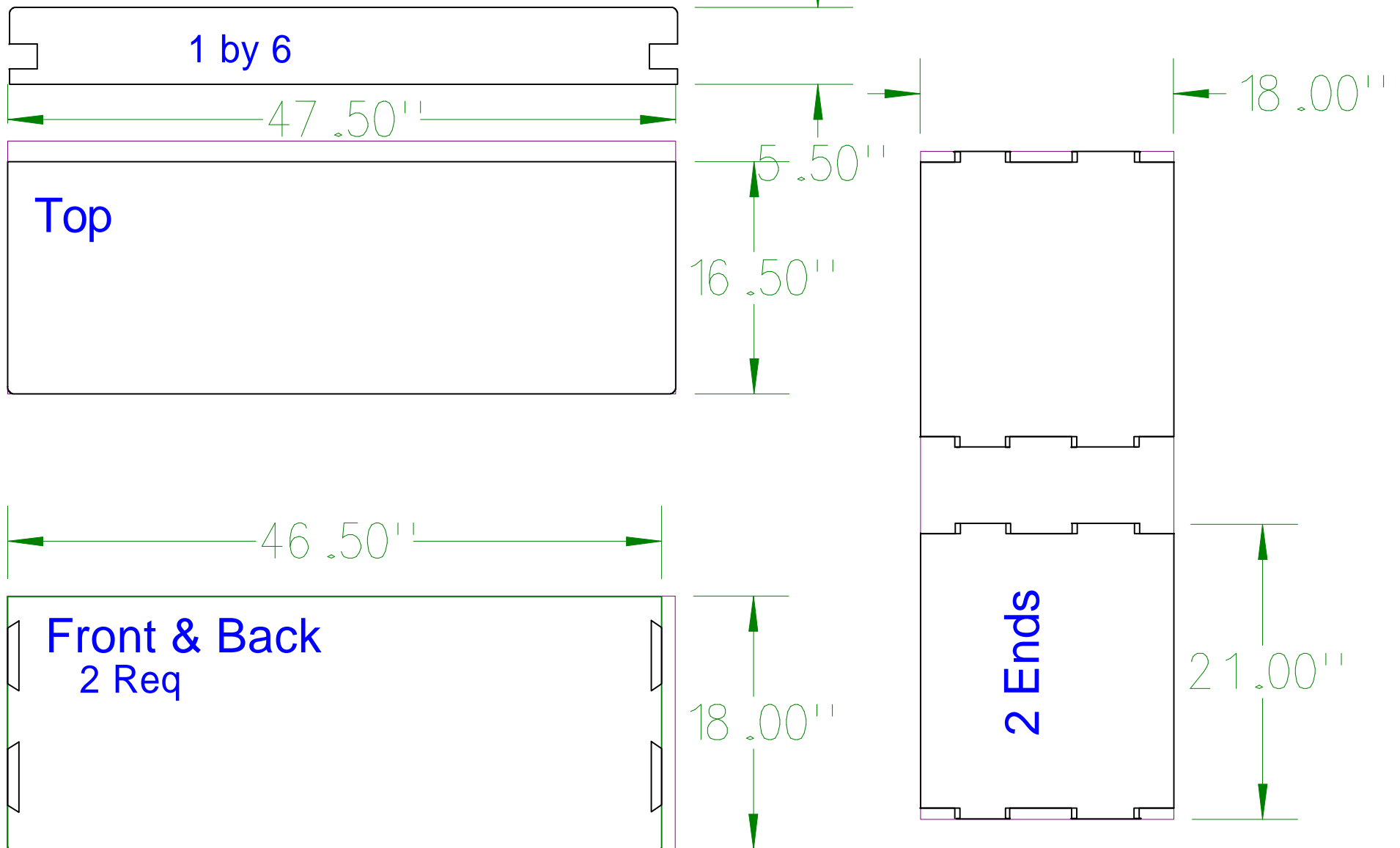

Child's Bench Toy Box

Bottom, Tray, & Secret, Sketch #4

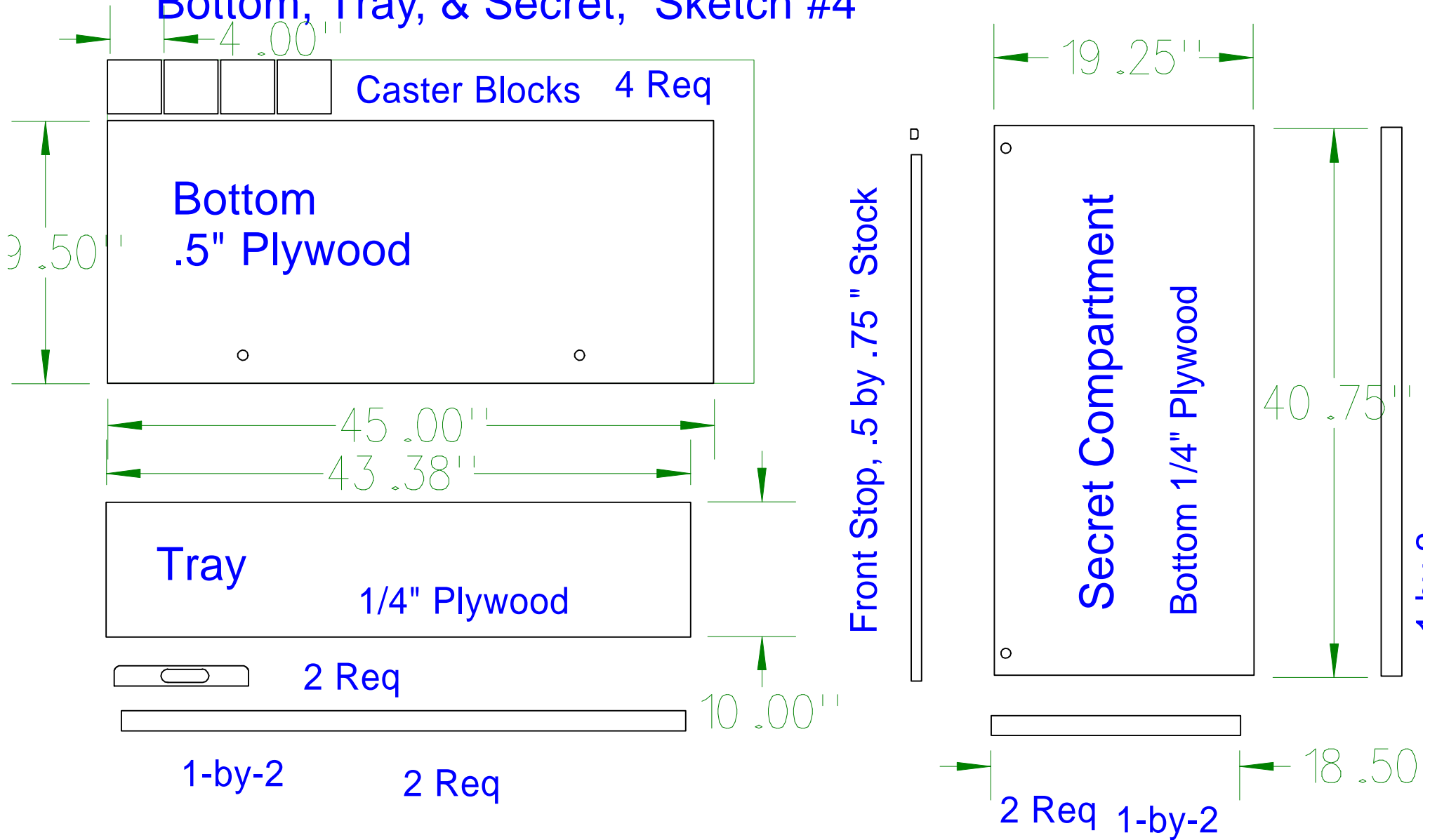

Child's Bench Toy Box

Dove Tail Gage, Sketch #6

